

CATALOGUE NUMBER: SQ-P12.60.2-3S / SQ-P12.60.2-3H

- Trouble free cutting of edge gate inside the mould during mould opening.
- Large edge gate to improve mould fill and packing.
- Reduces injection pressure and moulding cycle.
- It can be modified to the profile of the plastic part.
- It can be cut to size for ease of instalation.
- Economical interchangeable cutting insert.
- Supplied in soft (S) or hard (H) conditon.
- Manufactured from M2.

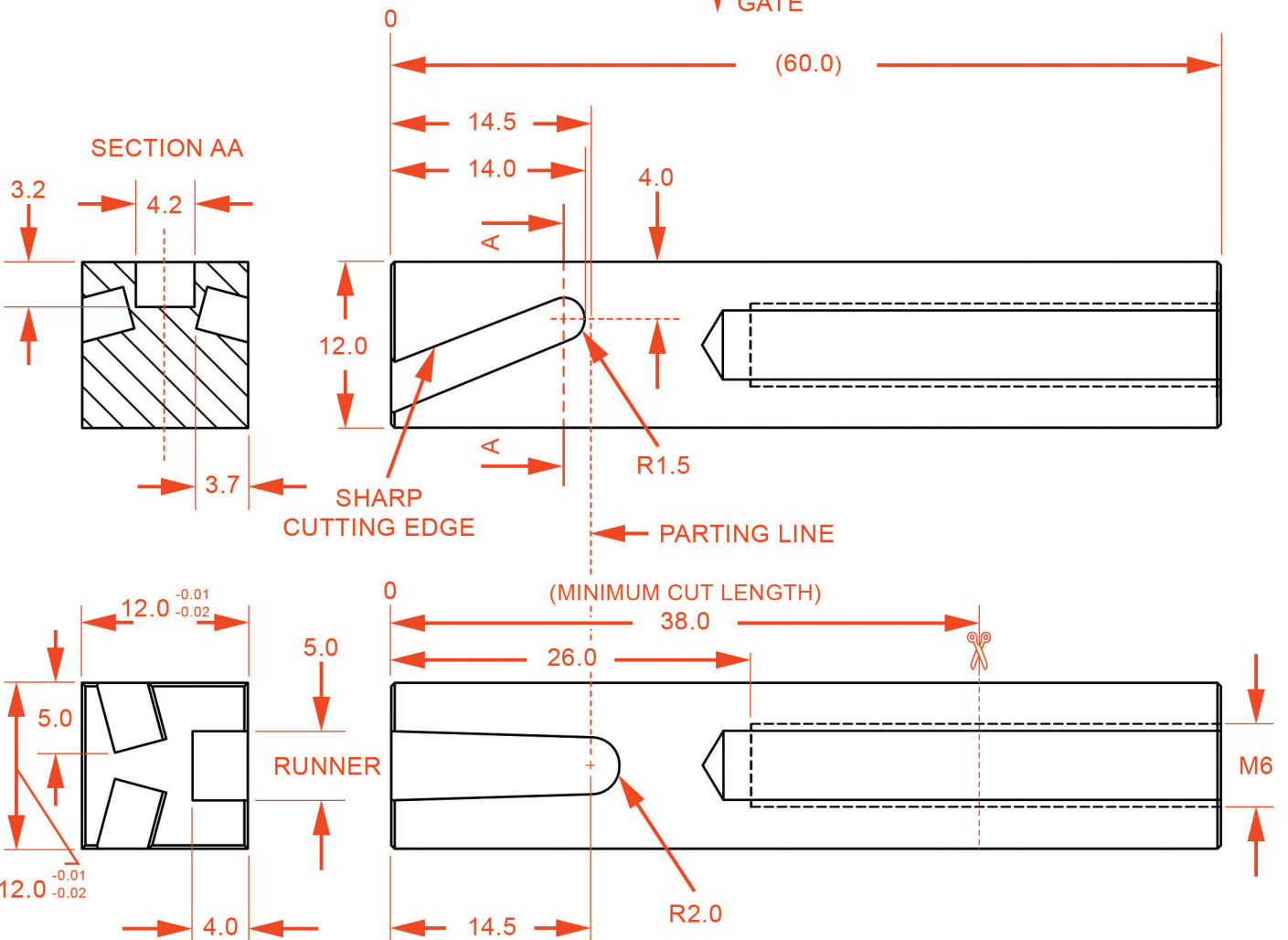
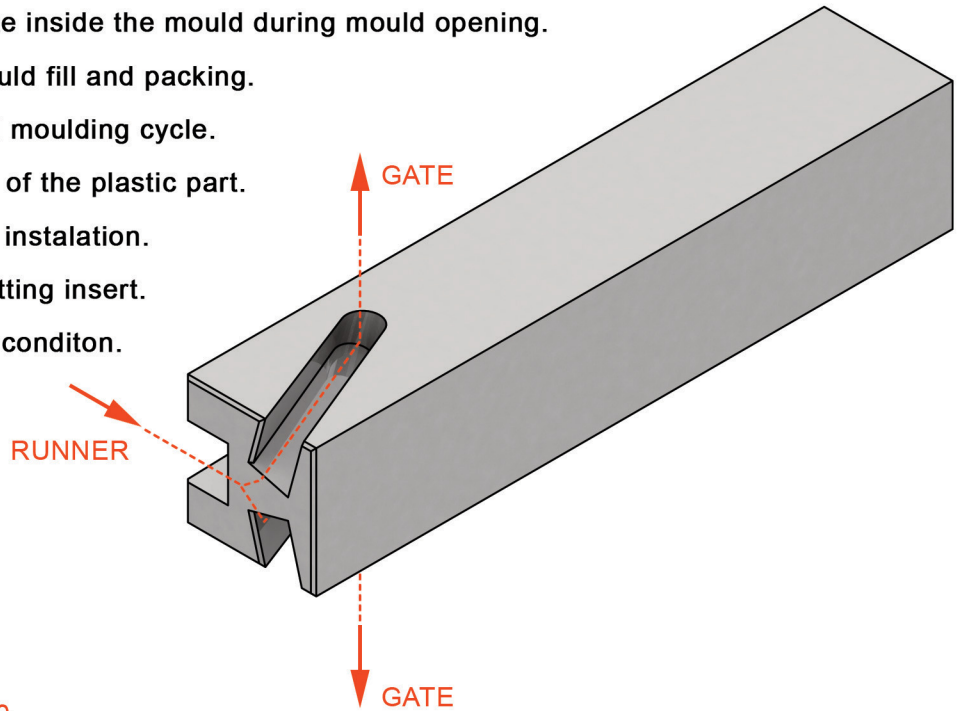

*Ejector plate must be held back during mould opening time.

PATENTED PRODUCT